



MAXMADE LIMITED

Flexible Protection Barrier Systems



Flexible Protection Barrier Systems

Maxmade Limited have been supplying the Clean Room and Temperature Controlled Building Industry since 1973. Initially only supplying specialist ceiling support systems and sheet metal fabrications.

Since this time, the company has gained a wealth of experience, and has developed its range of products to meet the new demands of this industry, and that of the Food Preparation Industry, including wall and door protection systems, wall and ceiling cladding systems and also supplying quality fixings and sealants to help complete the job.

Racking Protection

Rack Protection

RACK CORNER



Rack Corner:

- Anti Shock Material
- Easy to install
- Offers light traffic protection

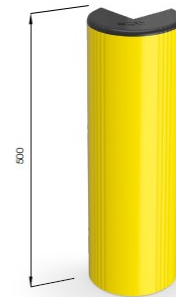

Rack End Barriers:

- Anti Shock Material
- Easy to install
- Different sizes available
- Can provide light to heavy traffic protection



RACK CORNER

Packing Colour to be defined

Equipped with accessories



Contact our sales team for more information on any of our range of products.



Re-seller of MPM Products

Hemmings Way, Off Stoney Lane,
Rainhill, Prescot, Merseyside L35 9ND
www.maxmade.com sales@maxmade.com
Telephone: 0151 430 9797

Racking Protection

LINK SINGLE RE



LINK SINGLE RE 1100x500
1100x800
2400x500
2400x800

Length 1.100 / 2.400 mm
Packing unpacked on pallet
Colour **B** **M**

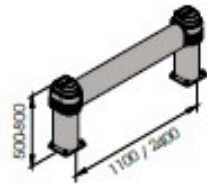

LINK SINGLE 2000x500 MODULAR
LINK SINGLE 2000x800 MODULAR

Packing unpacked on pallet
Colour **B** **M**

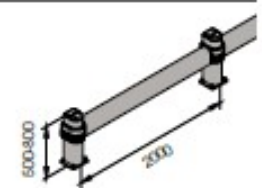

Equipped with accessories

Equipped with accessories



Contact our sales team for more information on any of our range of products.



Re-seller of MPM Products

Hemmings Way, Off Stoney Lane,
Rainhill, Prescot, Merseyside L35 9ND
www.maxmade.com sales@maxmade.com
Telephone: 0151 430 9797

Bollards

GRD 200

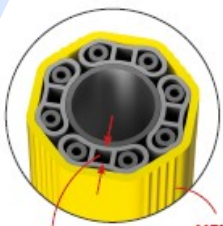

FLEXIBLE
NEW ANTISHOCK BUMPER



Bollard

GRD 150

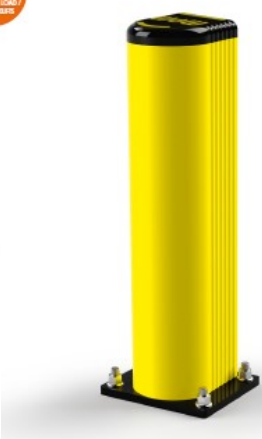

Bollard



INCLUDED



S16
GALVANISED STEEL

Bollards:

- Designed to protect access gates or to mark restricted areas for pedestrians
- Easy to install



GRD 200 1200 2000

Packing Colour M unpacked on pallet

Equipped with accessories



Contact our sales team for more information on any of our range of products.



Re-seller of MPM Products

Hemmings Way, Off Stoney Lane,
Rainhill, Prescot, Merseyside L35 9ND
www.maxmade.com sales@maxmade.com
Telephone: 0151 430 9797

Guard Rails

GUARD RAIL 90

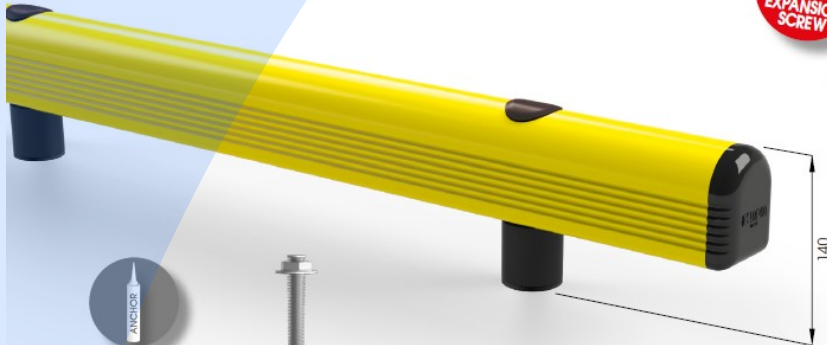

QUICK INSTALLATION WITH EXPANSION SCREW



M16 GALVANISED STEEL

- Guard Rails:**
- Easy to install
 - Different sizes



ALTERNATIVE FIXING
HIGH RESISTANCE WITH RESIN
SF16 STAINLESS STEEL

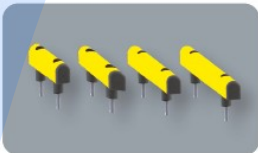

GR 90 500
750
1000
1500

Length 500 mm
Packing unpacked on pallet

Length 750 / 1000 / 1500 mm
Packing 2 pz / box

Equipped with accessories

Colour **B** **M**

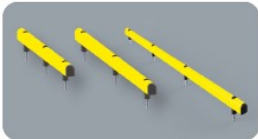
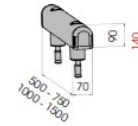

GR 90 2000
3000
4000

Length 2.000 / 3.000 / 4.000 mm
Packing unpacked on pallet

Colour **B** **M**

Equipped with accessories

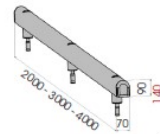

Guard Rails

GUARD RAIL 150

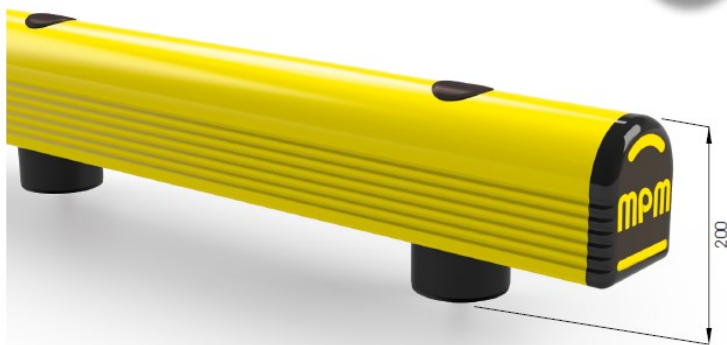

HIGH RESISTANCE WITH RESIN



SF20 STAINLESS STEEL



Contact our sales team for more information on any of our range of products.



Hemmings Way, Off Stoney Lane,
Rainhill, Prescot, Merseyside L35 9ND
www.maxmade.com sales@maxmade.com
Telephone: 0151 430 9797

Cold Line



Rod Range:

- Easy to install
- Different sizes



ROD 70



ROD 120



ROD FLOOR 70



M16 GALVANISED STEEL

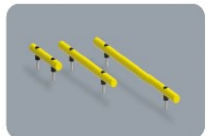
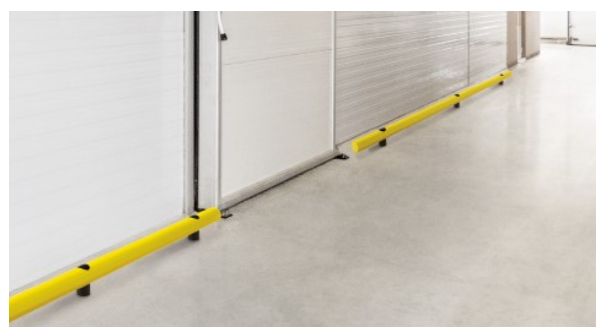

RF 70 500
1000
1500

Length 500 / 1000 / 1500 mm
Packing unpacked on pallet
Colour

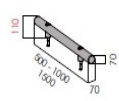

Equipped with accessories

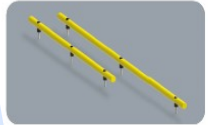

RF 70 2000
3000

Length 2,000 / 3,000 mm
Packing unpacked on pallet
Colour

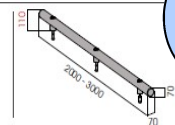

Equipped with accessories

Contact our sales team for more information on any of our range of products.



Re-seller of MPM Products

Hemmings Way, Off Stoney Lane,
Rainhill, Prescot, Merseyside L35 9ND
www.maxmade.com sales@maxmade.com
Telephone: 0151 430 9797

Cold Line



- Rod Range:**
- Easy to install
 - Different sizes

ROD FLOOR 120



Cold Line



SF20 STAINLESS STEEL



ROD FLOOR 120 DOUBLE RE



SF20 x 450 STAINLESS STEEL

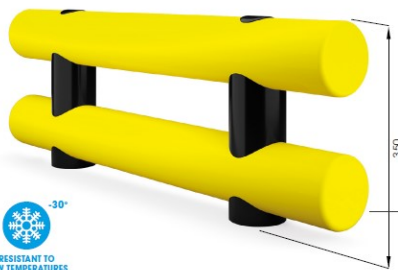

NOT SHARP EDGES



Contact our sales team for more information on any of our range of products.



Hemmings Way, Off Stoney Lane,
Rainhill, Prescot, Merseyside L35 9ND
www.maxmade.com sales@maxmade.com
Telephone: 0151 430 9797

Pedestrian Systems

Pedestrian Safety Barriers

PEDESTRIAN 90



FAST AND EASY TO INSTALL



M12 GALVANISED STEEL



PED 90 1500x1150 MODULAR

Packing Colour **unpacked on pallet**
B M



Equipped with accessories



PED 90 1500x1150 CORNER

Packing Colour **unpacked on pallet**
B M

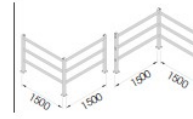

Equipped with accessories

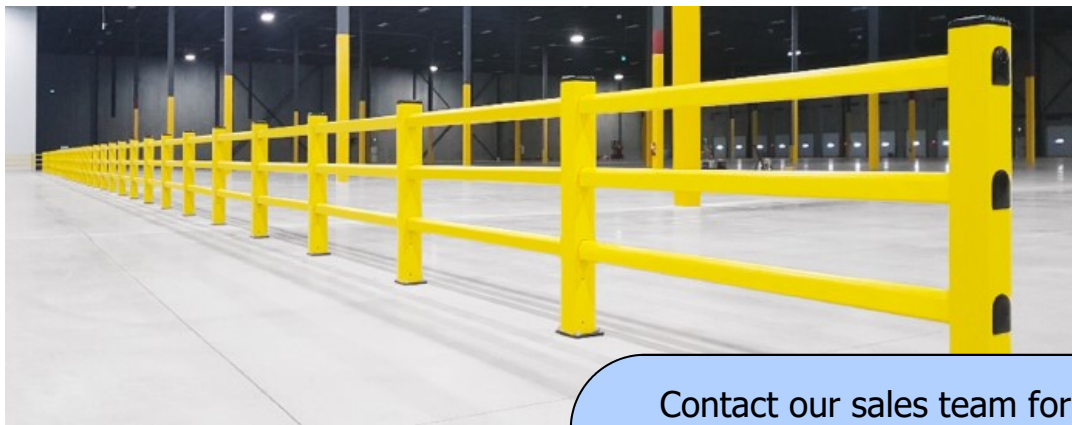

Contact our sales team for more information on any of our range of products.

Pedestrian Barriers:

- Easy to install
- Different sizes



Re-seller of MPM Products

Hemmings Way, Off Stoney Lane,
Rainhill, Prescot, Merseyside L35 9ND
www.maxmade.com sales@maxmade.com
Telephone: 0151 430 9797

B Flex System

B FLEX.FRONT/1

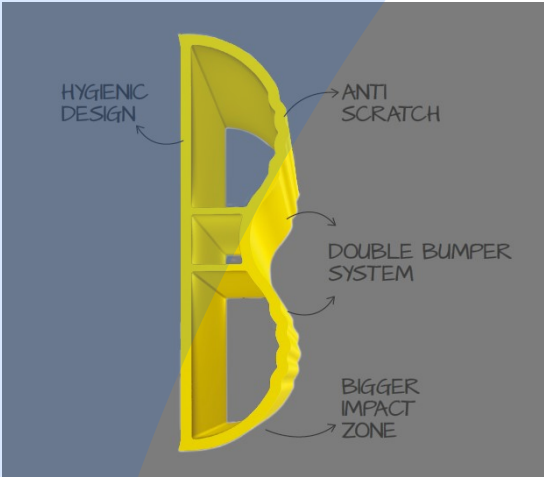

BFLEX.FRONT/1 1100x450
BFLEX.FRONT/1 2400x450

Length 1.100 / 2.400 mm
Packing unpacked on pallet
Colour M



Equipped with accessories



BFLEX.FRONT/1 2000x450
MODULAR

Packing unpacked on pallet
Colour M

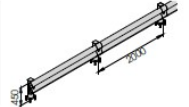

Equipped with accessories

B FLEX.FRONT/2



B Flex:

- Easy to install
- Different sizes
- Double bumper
- Large impact zone



Contact our sales team for more information on any of our range of products.



Hemmings Way, Off Stoney Lane,
Rainhill, Prescot, Merseyside L35 9ND
www.maxmade.com sales@maxmade.com
Telephone: 0151 430 9797

Column Protection



HUG TOWER



Column protection



NO HOLES ON THE FLOOR AND COLUMN!

CHOOSE THE HEIGHT YOU NEED!

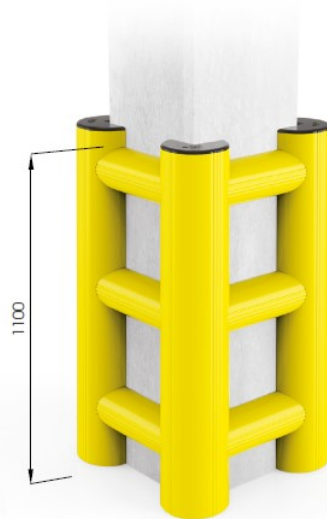
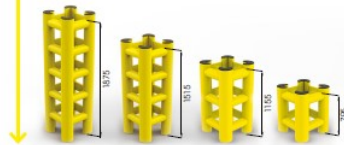

TOWER LINK



Column protection



M12 GALVANISED STEEL

Column Protection:

- Easy to install
- Different options
- Some require no holes

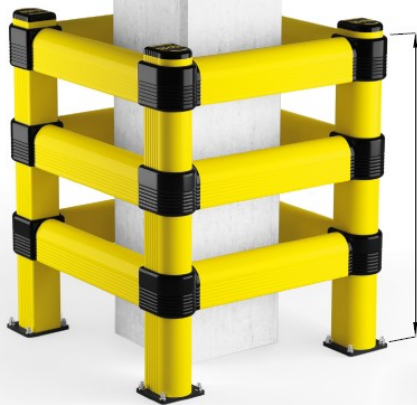

OPTIONS



TOWER LINK/1

TOWER LINK/2

TOWER LINK/3

COLUMN PROTECTION 90



Contact our sales team for more information on any of our range of products.



Black

Red

140

M16 STAINLESS STEEL



Hemmings Way, Off Stoney Lane,
Rainhill, Prescot, Merseyside L35 9ND
www.maxmade.com sales@maxmade.com
Telephone: 0151 430 9797

Door Frame Protection

Door frame protection

FULL FRAME SELF STANDING



NEW BIGGER PLATES!

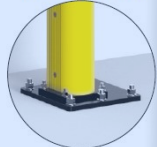

Door Frame Protection:

- Easy to install
- Different options
- Up to 5000 lengths



FFB SELF STANDING

Packing Colour to be defined

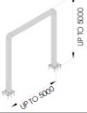

Equipped with accessories



Door frame protection

FULL FRAME WALL FIXING



WALL FIXING ACCESSORIES



FFB WALL FIXING

Packing Colour to be defined



Equipped with accessories



Contact our sales team for more information on any of our range of products.



Hemmings Way, Off Stoney Lane,
Rainhill, Prescot, Merseyside L35 9ND
www.maxmade.com sales@maxmade.com
Telephone: 0151 430 9797



Re-seller of MPM Products

Door Frame Protection

Door frame protection

FULL FRAME SELF STANDING



NEW BIGGER PLATES!

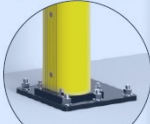

Door Frame Protection:

- Easy to install
- Different options
- Up to 5000 lengths



FFB SELF STANDING

Packing Colour to be defined



Equipped with accessories



Door frame protection

FULL FRAME WALL FIXING



WALL FIXING ACCESSORIES

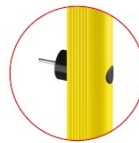

FFB WALL FIXING

Packing Colour to be defined



Equipped with accessories



Contact our sales team for more information on any of our range of products.



Hemmings Way, Off Stoney Lane,
Rainhill, Prescot, Merseyside L35 9ND
www.maxmade.com sales@maxmade.com
Telephone: 0151 430 9797



Re-seller of MPM Products